

Buchman
7250 Holiday Blvd
Guemes Island
Anacortes WA 98221
matthew@mlbuchman.com

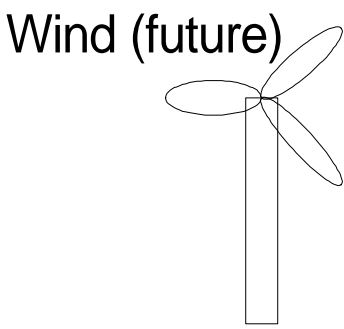

All chassis
go to ground.
All grounds
connected.
1 rod at each
PV array,
2 at meter.

ground & neutral
bonded in:
AC Load 1
(for 120VAC)
& AEI
(for 48VDC)

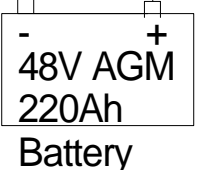
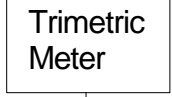
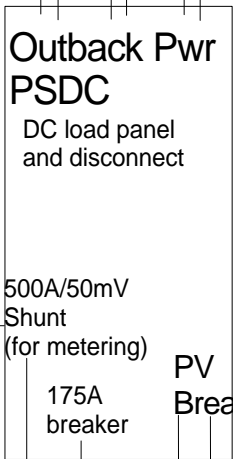
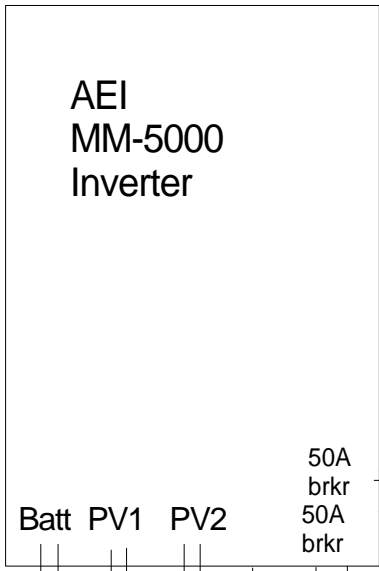
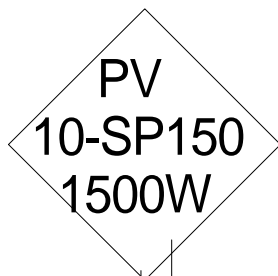

Panels connected
in 2 panel subarrays
for 48VDC

Each array presently
populated to
6 panels
totaling 900W.

2 identical
arrays

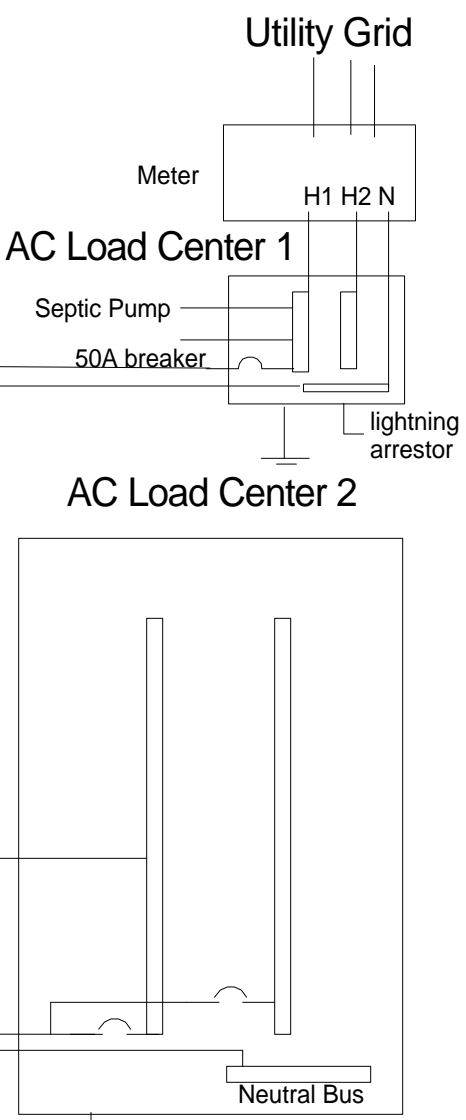
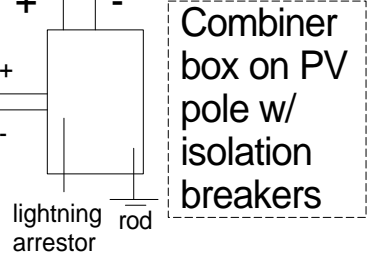

kWh meters
for additional
monitoring

lightning
arrestor

lightning
arrestor

lightning
arrestor